



ELECTRIC VEHICLE CHARGER EVC12 VESPER MOBILE SERIES

Installation Guideline



CONTENTS

1 - SAFETY INFORMATION	2
1.1 - SAFETY WARNINGS	2
1.2 - INSTRUCTIONS FOR DEALING WITH A FIRE AT ELECTRIC VEHICLE CHARGING STATION	3
1.3 - GROUND CONNECTION WARNINGS	4
1.4 - POWER CABLES, PLUGS AND CHARGING CABLE WARNINGS	4
1.5 - PROTECTIONS REQUIRED BEFORE SYSTEM.....	5
2 - DESCRIPTION.....	6
3 - GENERAL INFORMATION.....	7
3.1 - INTRODUCTION OF THE PRODUCT COMPONENTS	7
3.2 - DIMENSIONAL DRAWINGS	8
4 - REQUIRED EQUIPMENT, TOOLS and ACCESSORIES	9
4.1 - SUPPLIED INSTALLATION EQUIPMENTS and ACCESSORIES	9
4.2 - RECOMMENDED EQUIPMENTS and TOOLS.....	10
5 - ELECTRICAL SPECIFICATION	11
6 - USER INTERFACE & AUTHENTICATION.....	11
7 - CONNECTIVITY	12
8 - MECHANICAL SPECIFICATIONS	12
9 - ENVIRONMENTAL TECHNICAL SPECIFICATIONS	12
10 - INSTALLING CHARGING STATION	13
10.1 - UNPACK CHARGING STATION	13
10.2 - OPENNING FRONT COVERS	14
10.3 - CABLE INSTALLATION	14
10.3.1 - OPENING THE FRONT COVER AND CABLE CONNECTION	14
10.3.2 - SIM CARD CONNECTION	15
10.4 - COMISSIONNING.....	16
10.4.1 - CONNECT PC TO THE SAME NETWORK WITH HMI BOARD.....	16
10.4.2 - OPENING WEB CONFIGURATION INTERFACE WITH BROWSER	16
10.4.3 - WEB CONFIGURATION INTERFACE.....	18
10.4.3.1 - GENERAL SETTINGS	19
10.4.3.2 - OCPP SETTINGS.....	19
10.4.3.3 - NETWORK INTERFACES	19
10.4.3.4 - POWER MANAGEMENT.....	20
10.4.3.5 - SYSTEM MAINTENANCE.....	20
10.5 - CLOSE COVER	21
11 - PERIODIC MAINTENANCE LIST	22
12 - WIRELESS LAN TRANSMITTER SPECIFICATIONS	24

1 - SAFETY INFORMATION



CAUTION
RISK OF ELECTRIC SHOCK



CAUTION: ELECTRIC VEHICLE CHARGER DEVICE SHALL BE MOUNTED BY A LICENSED OR AN EXPERIENCED ELECTRICIAN AS PER ANY REGIONAL OR NATIONAL ELECTRIC REGULATIONS AND STANDARDS IN EFFECT.



CAUTION



AC grid connection and load planning of the electric vehicle charging device shall be reviewed and approved by authorities as specified by the regional or national electric regulations and standards in effect. For multiple electric vehicle charger installations the load plan shall be established accordingly. The manufacturer shall not be held liable directly or indirectly for any reason whatsoever in the event of damages and risks that are borne of errors due to AC grid supply connection or load planning.



CAUTION: FOR DEVICES WITHOUT EMERGENCY BUTTON;

If any suspicious or emergency situation arises at the charging station aside from normal operation, start by halting the charging process through the vehicle (using the appropriate switch or button, which may vary depending on the model), and then disconnect the socket. As an alternative option, consider switching off the MCB or RCCB in the panel where the product is energized by the installer.

IMPORTANT - Read these instructions fully before installing or operating

1.1 - SAFETY WARNINGS

- Keep this manual in a safe place. These safety and operating instructions must be kept in a safe place for future reference.
- Check that the voltage marked on the rating label and do not use charging station without appropriate mains voltage.
- Do not continue to operate the unit if you are in any doubt about it working normally, or if it is damaged in any way - switch off the mains supply circuit breakers (MCB and RCCB) in upstream distribution panel. Consult your local dealer.
- The ambient temperature range during charging should be between $-35\text{ }^{\circ}\text{C}$ and $+50\text{ }^{\circ}\text{C}$ (without direct sunlight) and at a relative humidity of between 5 % and 95 %. Use the charging station only within these specified operating parameters.
- The device location should be best selected to avoid excessive heating of the charging station. High operating temperature caused by direct sunlight or heating sources, may cause reduction of charging current or temporary interruption of charging process.
- The charging station is intended for outdoor and indoor use. It can also be used in public places.
- To reduce the risk of fire, electric shock or product damage, do not expose this unit to severe rain, snow, electrical storm or other severe weathers. Moreover, the charging station shall not be exposed to spilled or splashed liquids.

- Do not touch end terminals, electric vehicle connector and other hazardous live parts of the charging station with sharp metallic objects.
- Avoid exposure to heat sources and place the unit away from flammable, explosive, harsh, or combustible materials, chemicals, or vapors.
- Risk of Explosion. This equipment has internal arcing or sparking parts which should not be exposed to flammable vapors. It should not be located in a recessed area or below floor level.
- To prevent risk of explosion and electric shock, ensure that the specified Circuit Breaker and RCD are connected to building grid.
- Charging Station bottom must be at (or above) the ground level.
- Adaptors or conversion adaptors are not allowed to be used. Cable extension sets are not allowed to be used.



WARNING: Never let people (including children) with reduced physical, sensory or mental capabilities or lack of experience and or knowledge use electrical devices unsupervised.



CAUTION: This vehicle charger unit is intended only for charging electric vehicles not requiring ventilation during charging.

1.2 - INSTRUCTIONS FOR DEALING WITH A FIRE AT ELECTRIC VEHICLE CHARGING STATION

- **Personal Safety:** If you notice a fire or signs of danger, your own safety is the most important. Do not take risks.
- **Immediate Notification of Emergency Services:** Contact the appropriate emergency services in your region. Dial 998 or 112 the emergency number.
- **Discontinuing Charging:** If safe to do so, disconnect the charging cable from the vehicle and the charging station.
- **Use of Fire Extinguishing Agents:** If a fire extinguisher or other fire-fighting equipment is nearby and you are trained to use them, attempt to extinguish the fire. However, never risk your own safety.
- **Avoid Direct Contact with the Fire:** Do not attempt to extinguish the fire if you do not have the appropriate equipment or knowledge, or if the fire is too large or dangerous.
- **Move Away from the Station:** If the fire is uncontrolled or growing in strength, move away from the charging station while maintaining a safe distance.
- **Avoid Inhaling Smoke:** Try to avoid inhaling smoke. If possible, cover your nose and mouth with a damp cloth or clothing.
- **Warn Others in the Area:** Inform others in the vicinity about the fire hazard and encourage them to leave the area.
- **Wait for Emergency Services:** After safely leaving the area, wait for the arrival of emergency services at a location that is safe for you.
- **No Return to the Station Premises:** Do not return to the charging station premises until the emergency services have completed their operation.
- **Reporting the Incident:** Contact customer support to report the incident.

Remember, safety is paramount. In the event of a fire, always consult with local emergency services and follow their instructions.

1.3 - GROUND CONNECTION WARNINGS

- Charging station must be connected to a centrally grounded system. The ground conductor entering the charging station must be connected to the equipment grounding lug inside the charger. This should be run with circuit conductors and connected to the equipment grounding bar or lead on the charging station. Connections to the charging station are the responsibility of the installer and purchaser.
- To reduce the risk of electrical shock, connect only to properly grounded outlets.
- **WARNING** : Make sure that during installing and using, the charging station is constantly and properly grounded.

1.4 - POWER CABLES, PLUGS and CHARGING CABLE WARNINGS

- Be sure that plugs and sockets are compatible on charging station side.
- A damaged charging cable can cause fire or give you an electric shock. Do not use this product if the flexible Charging cable or vehicle cable is frayed, has broken insulation, or shows any other signs of damage.
- Ensure that the charge cable is well positioned thus; it will not be stepped on, tripped over, or subjected to damage or stress.
- Do not forcefully pull the charge cable or damage it with sharp objects.
- Never touch the power cable/plug or vehicle cable with wet hands as this could cause a short circuit or electric shock.
- To avoid a risk of fire or electric shock, do not use this device with an extension cable. If the mains cable or vehicle cable is damaged it must be replaced by the manufacturer, its service agent, or similarly qualified persons in order to avoid a hazard.
- Use appropriate protection when connecting to the main power distribution cable.

1.5 - PROTECTIONS REQUIRED BEFORE SYSTEM

- Class I/B Lightning Protection should be connected to the upstream distribution board.
*The charger is equipped with a Class II/Type C Surge Protective Device (SPD).
- To prevent the residual current, Type A residual current device should be used on the panel before the device. The minimum current sensitivity should be set to 30mA.
- Circuit Breaker device should be connected to the upstream distribution box.

Model	Power	Input Voltage	Maximum Input AC current	Recommended Minimum Neutral Conductor Cross-Section
EVC12M-DC40C	40kW	400V (nom.)	62A	16mm ²
		360V (-%10)	68A	

• Cable cross-sections must be selected by the installer in accordance with local and international standards, considering the specified minimum and maximum AC input current values, installation distances, and mounting location conditions.

- The PE cable cross-section must be at least 16 mm².
- It is recommended to use a CAT6 SFTP Ethernet cable.
- Cables must be selected for outdoor use.
- Cables must be UV-protected and suitable for installation in underground conduits according in accordance with local regulations.
- The AC input cable glands supplied with the product are suitable for cables with a diameter range of 22–32 mm.

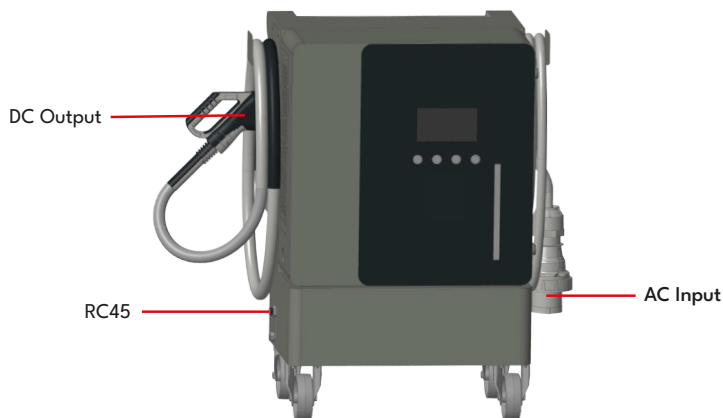

2 - DESCRIPTION

Model Name	EVC12M-DC40*Series 1st Asterisk (*) : Rated Power 40 : 40 kW DC Power Output 2nd Asterisk (*) : DC output combination 1 C : CCS Output
Cabinet	EVC12M-DC40

3 - GENERAL INFORMATION

3.1 - INTRODUCTION OF THE PRODUCT COMPONENTS



- 1-** Information Display
- 2-** Buttons
- 3-** Status Indicator LED
- 4-** Payment Terminal Area (Optional)
- 5-** RFID Card Reader
- 6-** Air filter and Access cover for Power Module
- 7-** DC Outlet
- 8-** Emergency Button
- 9-** Charging Station Ethernet connection cable gland nut
- 10-** Push-Pull Handle
- 11-** Cable Holder
- 12-** AC 3-phase industrial-type power plug
- 13-** Mobil Stand
- 14-** Wheels



3.2 - DIMENSIONAL DRAWINGS

LEFT SIDE VIEW

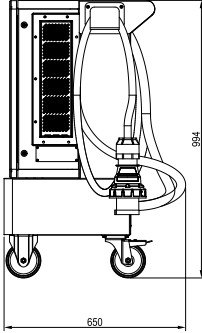

FRONT SIDE VIEW

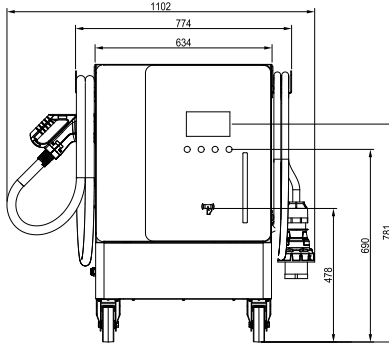

RIGHT SIDE VIEW

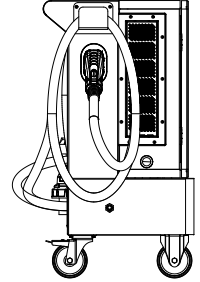

TOP SIDE VIEW

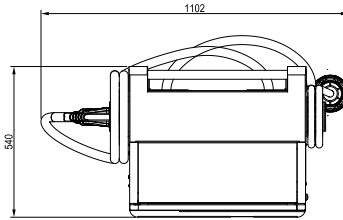













4 - REQUIRED EQUIPMENT, TOOLS and ACCESSORIES

4.1. - SUPPLIED INSTALLATION EQUIPMENTS and ACCESSORIES

Special Switch M50 x M40	
1 set Lock Keys (x2)	
Screw Torx T25 M5x15 Black (x4)	
Screw 6X50 Self Tap YHB 480H SUS304 (x12)	
Washer Flat M6 OD15 240H (x1)	
Plastic Dowel 8*50_(UX-77869) R1 (x12)	
Hanger Wall EVC12 (x1)	
Hanger Wall EVC12 PART1 (x1)	
Hanger Wall EVC12 PART2 (x1)	
Spacer Support MTL HX M6x15-15 M/F L200 (x1)	
Mounting Template	

4.2 - RECOMMENDED EQUIPMENTS and TOOLS

			
Ø20 Drill Bit	Impact Drill	PC	Philips Screwdriver
			
RJ45 Crimping Tool	Cat5e or cat6 ethernet cable	Spanner set	Hammer
			
M20 Steel Expansion Bolt x4	RJ45 Male Connector	T25 Screwdriver	20 - 200 Nm D: 40mm H: 43mm

5 - ELECTRICAL SPECIFICATION

IEC Protection class		Class I
Power Input	Input Rating	230/400 Vac $\pm 10\%$, 50/60 Hz, 62A /3 phase
	Connection	3L - N - PE (TN-S, TN-C-S or TT)
	Residual Current Monitoring	400Vac RCCB 3P+N, Type A, 30mA (system)
	Power Factor	> 0.98
	Efficiency	> % 95
CCS Output	Max Power	40 kW
	Voltage Range	200 – 920 Vdc
	Maximum Current	133A
	Interface Compliance	IEC 62196-1 / 3 IEC 61851-1 / 23 / 24 ISO 15118-1 / 2 / 3 DIN 70121
Internal Protections		Residual current sensing (3P + N), Insulation monitoring, Over current / Over voltage / Under voltage / Short circuit / Over Temperature / Surge Protection

6 - USER INTERFACE & AUTHENTICATION

Display	7" Color TFT LCD without Touch Screen (16:9)
RFID Reader Module	ISO-14443A/B and ISO-15693
User Interface	Illuminated buttons
Plug&Charge	ISO15118

7 - CONNECTIVITY

LAN Connectivity	10/100 Mbps Ethernet
WLAN Connectivity	802.11 a/b/g/n/ac
Mobile Connectivity	GSM 900/1800 UMTS 900/2100 LTE Band 1/3/7/8/20/28A
OCPP Specification	OCPP 1.6 J

8 - MECHANICAL SPECIFICATIONS

Material	Sheet Metal	
Protection Degree	Ingress Protection Impact Protection	IP54 IK10
Cooling	Forced Air Cooling Fan	
Cable Length	AC Input: 5m(default) or optional CCS2 : 3,5m(default) or 5m(option)	
Dimensions (Product)	650x774x994mm (DxWxH)	
Dimensions (with packing)	700x1170x1220mm (DxWxH)	
Weight (Product)	137kg	
Weight with Package	186kg	

9 - ENVIRONMENTAL TECHNICAL SPECIFICATIONS

Operating Condition	Temperature	-35°C to + 50 °C (Derating is applied over + 40 °C to 50 °C) For products with credit card option -20°C to + 50°C
	Humidity	5 % - 95 % (Relative humidity, non-condensing)
	Altitude	0 - 2000m

10 - INSTALLING CHARGING STATION

Screws inside the product are recommended to be exceeding 240 hours Salt Fog test under ASTM B117 Method. Screws outside the product are recommended to be exceeding 720 hours.



WARNING: RISK OF ELECTRICAL SHOCK AND INJURY. POWER OFF THE CHARGING STATION MAIN SUPPLY BEFORE ANY INSTALLATION STEPS.



WARNING: TO AVOID PERSONAL INJURY OR DAMAGE THE CHARGING STATION, ENSURE THE INSTALLATION AREA IS SUITABLE AND THE FLOOR CAN WITHSTAND THE WEIGHT OF THE CHARGING STATION.

10.1 - UNPACK CHARGING STATION

Unpack the charging station as shown in figures below.

Unscrew all bolts located at the front, rear, and side corners of the crate before removing the top cover.

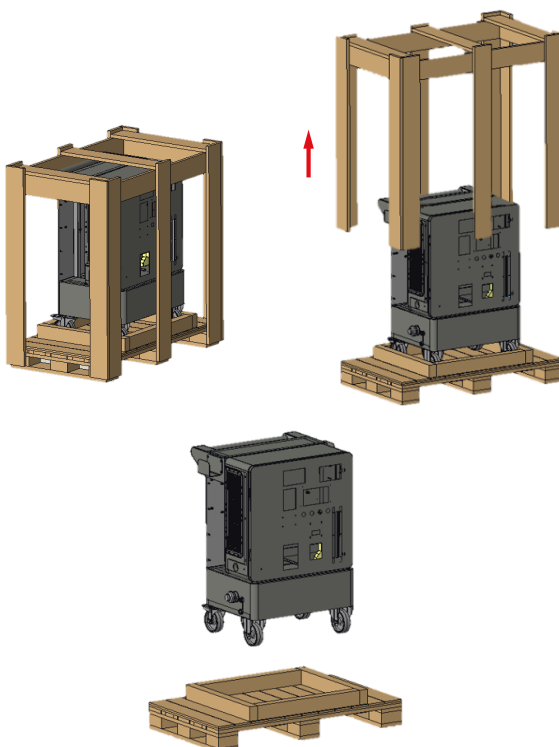

10.2 - OPENING FRONT COVERS

Use the key provided to open the front cover.

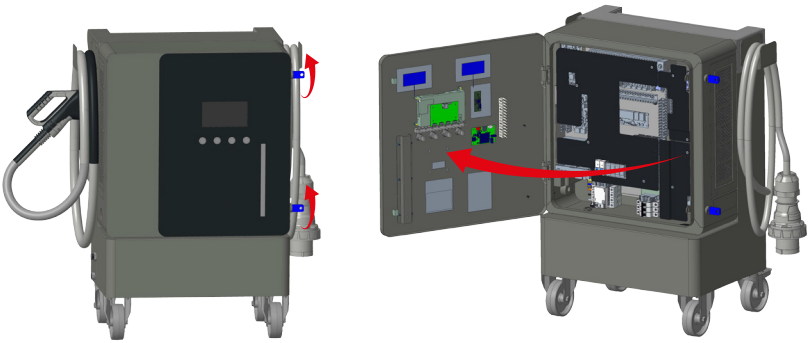

10.3 - CABLE INSTALLATION

10.3.1 - OPENING THE FRONT COVER AND CABLE CONNECTION

1- Open the front cover of the product by turning the two lock sockets located on the right side surface counterclockwise using the key provided with the product.

2- Remove the screws and isolator plate covering the AC Mains cable in the left side.

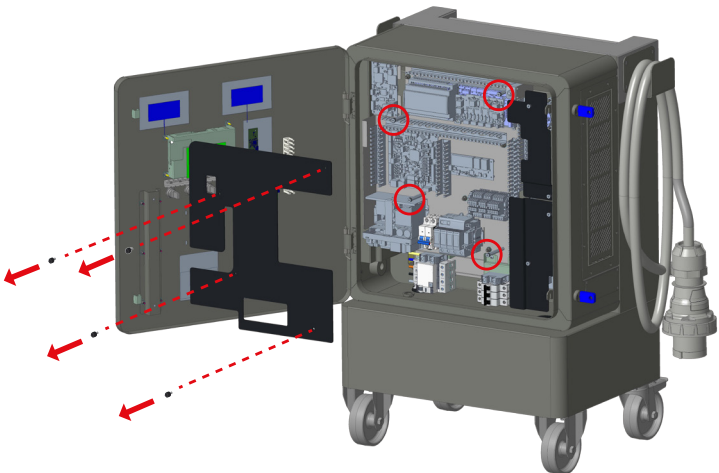

10.3.2 - SIM CARD CONNECTION

See “Opening the front covers” section and insert the Micro SIM card into the cellular communication module SIM card slot as shown in the figure below.

Ghost OCPP provides the communication between the charging station and the central system via a dedicated APN cellular network. With this system, the manufacturer will have the capability to remotely control any device that has been installed in the field and supported by Ghost OCPP at any time. Thus, controlling the instant status of the products, sending remote commands to the product (restarting the product, diagnostic message), usage data and logs related to the product will be accessible 24/7. With this process, device intervention and controls in the field can be performed quickly/effectively. Within the scope of Ghost OCPP, the manufacturer inserts the SIM card into the Ghost OCPP card and sends it to the field after activating. The management of the Ghost OCPP card is in the charge of the manufacturer.

Remote monitoring GSM Module

OCPP Connection GSM Module

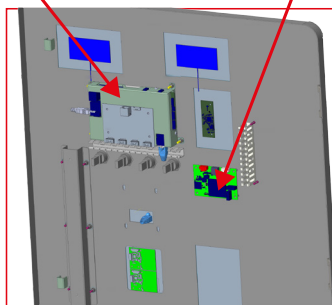

10.4 - COMMISSIONING

10.4.1 - CONNECT PC TO THE SAME NETWORK WITH HMI BOARD

In order to access Web Config UI, first you need to connect your PC and EV charger to the same ethernet switch or connect EV charger to your PC directly.

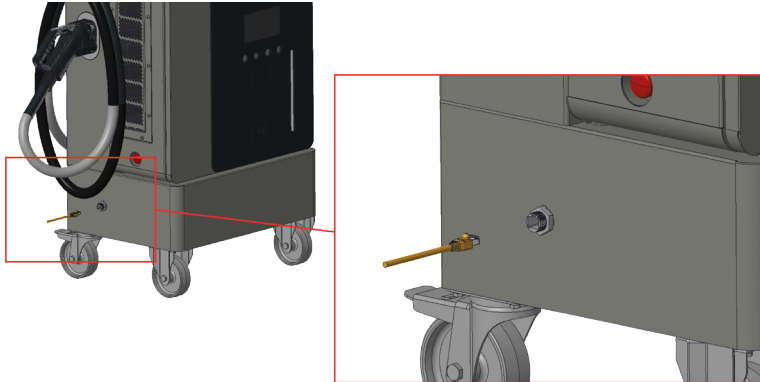

Power-on the charging station. Default IP address of HMI board is 192.168.0.10. For this reason, you need to give static IP to your PC in the same network with HMI board.

You should assign static IP address to your PC in 192.168.0.0/254 network which means that IP address should be in a range of between 192.168.0.1 and 192.168.0.254.

For example, 192.168.0.11 can be set as an static IP to your PC.

10.4.2 - OPENING WEB CONFIGURATION INTERFACE WITH BROWSER

Open your web browser and type 192.168.0.10 which is IP address of HMI board.

You will see login page on your browser;

Each product has a user name and password set as factory configuration.

In this section you can log in to the Web configuration interface by entering the configuration information printed on the label. User Name and Password informations are located on the label pasted to the Quick Start Guide as shown below.

Only for the first login you will be forced to change your password.

You can change password with Change Password Button in WEBUI login page or Administration Password section in the System Maintenance tab.

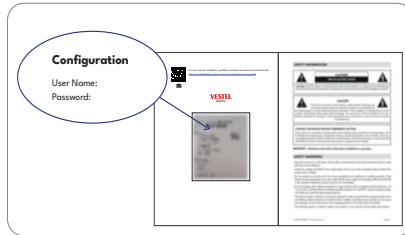

Visual representation is provided

Change Password:

If you click the “Change Password Button“ you will be redirected to the Change Password page.

Your password must be minimum 12 maximum 32 character and it contains at least two uppercase letters two lower case letters two number digits and two special characters.

After typing your current password and new password twice, you will be redirected to the login page again to log in with your new password.

CHANGE PASSWORD

Your password must be minimum 12, maximum 32 characters and it contains at least two uppercase letters, two lower case letters, two number digits and two special characters.

User Name:

Current password:

New password:

Confirm new password:

SUBMIT

[Back to Login](#)

10.4.3 - WEB CONFIGURATION INTERFACE

You can change the web configuration interface language and log out of the web configuration interface with the buttons in the upper right corner of the page.

MAIN PAGE	<p>The Main page provides an overview of the key system information and connection status of the EVC device. Below are the descriptions of each displayed parameter:</p> <p>CP Serial Number: Unique serial number of the device. It is used for device authentication and remote management.</p> <p>HMI Software Version: The software version of smart board (HMI) that runs the device's touchscreen interface.</p> <p>Power Board Software Version: The version of the software that controls power management and charging operations of device.</p> <p>PLC Software Version: The software version of power line communication board.</p> <p>VCR Software Version: The software version of the VCR (Voltage Current Resistance) board.</p> <p>CTB Software Version: The software version of the CTB (Control Board) board.</p> <p>OCPP Software Version: The version of the Open Charge Point Protocol (OCPP) software, which enables communication with the charging network management system.</p> <p>Duration after Power On: The total time (in hours, minutes, and seconds) that has passed since the device was last powered on. Useful for uptime tracking and performance monitoring.</p> <p>Connection Interface: The current communication method used by device. It can be Ethernet, WLAN (Wi-Fi), or Cellular.</p> <p>OCPP Device ID: Unique identification number used by device when communicating with OCPP server.</p> <p>Connector ID 1 Status: The current status of charging Connector 1 (e.g., Available, Plugged, Charging, Faulted).</p>
------------------	--

10.4.3.1 - GENERAL SETTINGS

Default Interface Languages	HMI display language and web interface language can be selected from the general settings page.
Display Settings	<ul style="list-style-type: none"> • Static - Set brightness/outdoor lighting to a fixed level, options include Low/Medium/High • Sensor Based - Display brightness is changed based on given sensor value thresholds. • Reduced Brightness in Inactive Mode - Sets automatic brightness dimming when the screen is not in use. This option can be enabled or disabled. • Minimum Brightness Value - Defines the minimum brightness for inactive mode. • Show Charge Point ID - Displays the charge point ID on screen (can be enabled/disabled).
Display Logo (Optional)	The user can upload left and right logos to display in the app UI and toggle their visibility using a switch button.
Tilt Threshold	The user can change the tilt threshold in angle. The tilt threshold as an angle is set to 30 for all angles by default. Tilt Threshold Range: 12 - 90
Display QR Code	The user can update the QR Code Settings for each connector on the device. QR Code can be enabled/disabled and if enabled, a limiting value for the QR Code String can be set.
Customer Service Number	You can reach customer service number from WEB UI screen. You can enable or disable it to display on the screen.

10.4.3.2 - OCPP SETTINGS

The required settings for the OCPP connection (activating and deactivating the OCPP connection, entering the connection address, entering the charging station ID, etc.) are made on this page.

10.4.3.3 - NETWORK INTERFACES

There are three types of network interfaces in this page; Cellular, Ethernet (LAN), Wi-Fi. Select interfaces' modes as "Enabled" if you want to activate it. You should fill all spaces in suitable formats.

10.4.3.4 - POWER MANAGEMENT

DC Output Configuration	DC Output Configuration(deprecated-will be renamed as Model Code).
Charge Point Maximum Power	Maximum Power value is used to set the maximum output power delivered from charging station.
Fail Safe Power	Fail Safe Power Limiting feature is used to limit the station output power when the OCPP Server connection is lost. When feature is enabled, the user can set output power value. The default value is 10 kW.
Power Module Configurations	DC power sharing enabled option is used to allow CPO to decide if power sharing will be active for 40 kW power module.
Connector Settings	Connector type and corresponding maximum output power is displayed under Connector Settings menu.

10.4.3.5 - SYSTEM MAINTENANCE

Log Files	The logs related to the device can be downloaded from this section.
Firmware Updates	The firmware file of device can be uploaded and upgraded.
Configuration Backup & Restore	The device-related configurations can be backed up and restored from this tab.
System reset	You can proceed to this section to perform Hard Reset and Soft Reset.
Administration Password	The administrator password can be changed from this tab.
Factory Default Configuration	You can reset your device to its factory settings.

10.5 - CLOSE COVER

1. Place the (left and right) bottom side plates back and tighten the bolts.
2. Ensure all the cables and plugs are not damaged.
3. Place and tighten the screws of the isolator plate covering the AC Mains cable.

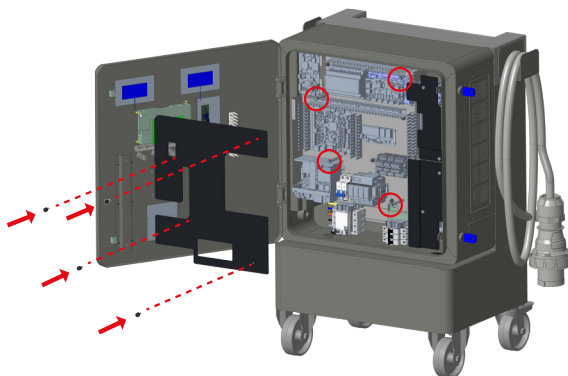

4. Switch on the MCBs (2P & 3P).

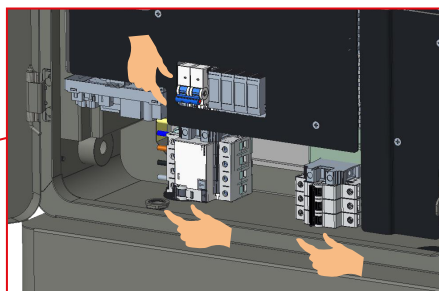
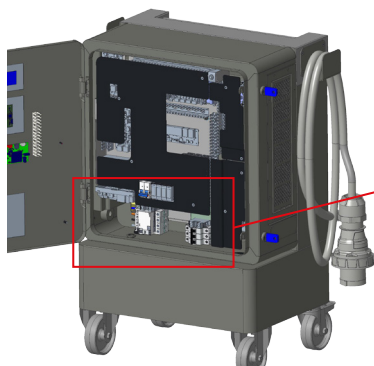

- 5- Close the right side cover of the product by turning the handle clockwise as shown in the section "Opening side covers" using the keys provided.

11 - PERIODIC MAINTENANCE LIST

	Maintenance Period (year)									
	1	2	3	4	5	6	7	8	9	10
Air filters	R	R	R	R	R	R	R	R	R	R
Plugs	I	I	I	I	I	I	I	I	I	I
Display	C	C	C	C	C	C	C	C	C	C
Distribution elements (RCCB, MCB)	T	T	T	T	T	T	T	T	T	T
AC input terminals	T	T	T	T	T	T	T	T	T	T
DC relay terminals	T	T	T	T	T	T	T	T	T	T
DC output cable and terminals	T	T	T	T	T	T	T	T	T	T
Body	C	C	C	C	C	C	C	C	C	C
Grounding resistance	M	M	M	M	M	M	M	M	M	M

C : Clean

I : Inspect (check, approve, clean, tighten or replace if necessary)

M : Measure

T : Tighten

R : Review

Air filters

Air filters should be replaced every year when going for maintenance.

Plugs

All spark plugs should be checked when going for maintenance. If the plug is broken or cracked, it should be replaced. Furthermore, a charging test should be performed with all Plugs.

Display

During maintenance, the screen should be checked using the physical buttons, as the screen is nontouch. All functions can be controlled through these buttons. If there is no issue with the button operations, the screen should be cleaned.

Distribution elements (RCCB, MCB)

Distribution elements (RCCB, MCB) should be checked and tightened when going for maintenance. These elements can be tightened with a screwdriver with a torque of 2 Nm.

AC input terminals

The AC input terminals should be checked and tightened when going for maintenance. These terminals should be tightened with a torque of 8 Nm for metric 8 bolts and 10 Nm for metric 10 bolts.

DC relay terminals

DC relay ends should be checked when going for maintenance. Tightening process should be performed with 6.5 Nm.

DC output cable and terminals

DC output cable and terminals should be checked when going for maintenance. They should be checked for any damage.

Body

The outer cabinet should be cleaned when going for maintenance.

Grounding resistance

A mechanism for measuring with a megger should be installed when going for maintenance. After the piles are driven, the voltage between the two piles should be less than 1V.

In cases where product transportation is required

During lifting, it is necessary to use 2 ropes of min 540mm (in case of using a single rope of L min=1080mm, the rope must be fixed from the middle lifting part).

During lifting, there should be a minimum angle of 60 degrees at both rope ends as shown in the image. Using a shorter sling will cause damage to the product.

12 - WIRELESS LAN TRANSMITTER SPECIFICATIONS

Frequency Ranges	Max Output Power
2400 - 2483,5 MHz (CH1 - CH13)	< 100 mW
5150 - 5250 MHz (CH36 - CH48)	< 200 mW (*)
5250 - 5350 MHz (CH52 - CH64)	< 200 mW (*)
5470 - 5725 MHz (CH100 - CH140)	< 200 mW (*)

(*) '< 100 mW' for the Ukraine

Country Restrictions

This Wireless LAN equipment is intended for home and office use in all EU countries, the UK and Northern Ireland (and other countries following the relevant EU and/or UK directive). The 5.15 – 5.35 GHz band is restrictions indoor operations only in in all EU countries, the UK and Northern Ireland (and other countries following the relevant EU and/or UK directive). Public use is subject to general authorisation by the respective service provider.

Country	Restriction
Russian Federation	Indoor use only
Israel	5 GHz band only for 5180 MHz-5320 MHz range

The requirements for any country may change at any time. It's recommended that user checks with local authorities for the current status of their national regulations for both 2.4 GHz and 5 GHz wireless LANs.

Hereby, Vestel Mobilite SAN. VE TİC. A.Ş., declares that the radio equipment type EVC is in compliance with Directive 2014/53/EU and Radio Equipment Regulations 2017. The full text of the EU declaration of conformity is available at the following address: doc.vosshub.com.

VESTEL

MOBILITY

VESTEL MOBİLİTE SANAYİ VE TİCARET A.Ş. EGE SERBEST BÖLGE ŞUBESİ

Zafer SB Mah. Ayfer Sok. No:22 İç Kapı No:1 Gaziemir, İzmir/ TÜRKİYE

Telefon (pbx) : 90 (232) 251 72 90 Fax : 90 (232) 251 73 13

Gaziemir V.D. : 837 001 0241

